



RevoProTM

Programmable Gobo Rotator



ver 1.1
Copyright 2011

TABLE OF CONTENTS

- A. Quick Set Up Guide
 - 1. Getting to Know your RevoPRO
 - 2. What's in the box
 - 3. Requirements
 - 4. Installing Gobos
 - 5. Installation and Power Supply
 - 6. Choosing the Mode of Operation
 - 7. Setting DMX Address and Operation Mode
 - 8. Precautions
 - 9. Troubleshooting
 - 10. Technical Specifications
 - 11. Accessories and replacement parts
 - 12. Compliance and Certifications
 - 13. Warranty

QUICK SET UP GUIDE

The RevoPRO™ Dual Programmable Rotator is quick and easy to configure using the LCD display.

1. Load a standard B size gobo into each gobo wheel. The threaded collar should be tightened until just in contact with the gobo. Do not over tighten. If using two metal gobos with fine elements in the design, place a Gobo Spacer Ring (Part no. 205 83007 0000) between the gobos to prevent warping and entanglement.

Tip: When screwing on the threaded collar, place one finger from each hand on the machined flat spots and slowly rotate the collar, keeping even pressure on both fingers. This helps the threads to engage evenly and prevents binding and cross threading.

2. Insert RevoPRO™ into a the iris slot of a compatible luminaire. Make sure unit is completely seated.
3. Engage Friction Lock by depressing plunger. Secure RevoPRO™ to the luminaire using a safety cable.
4. Connect an IEC 18AWG power cable to the appropriate power supply (100-240VAC 50/60hz).
5. Use LCD Display and buttons B1 – B4 to configure RevoPRO.
6. Press B1 to enter Setup mode. When display begins blinking, press B1 again to select desired Mode (1-7). Note: RevoPRO™ uses 2, 4, or 6 channels of DMX depending on the Operation Mode selected.
7. Set DMX Address using B2 – B4. Press B2 to set 100s place of desired DMX Address. Press B3 to set 10s place. Press B4 to set 1s place.
8. Display will now show, for example 1.001 to indicate Mode 1, DMX Address 001.
9. Press and hold B2 to save your configuration. RevoPRO™ will remember and restore your saved configuration on power up.
10. Adjust channels 1-6 (depending on Op Mode) on your lighting control desk to set speed, direction and index position of each gobo.
11. RevoPRO™ can be configured for stand alone operation, requiring no DMX control. See Section 7 inside for more instructions.

1. GETTING TO KNOW YOUR REVOPRO

RevoPRO™ Programmable Gobo Rotator

Advanced features and control options for any environment. DMX control with 7 modes of operation or console-free on board programming. Complete control even in spaces without lighting desks and universes of DMX like museums, retail, and commercial buildings. With its internal power supply, RevoPRO is perfectly suited in lighting rigs where an external PSU is not desirable, like theme parks and cruise ships. RevoPRO™ is a powerful and versatile tool for creating subtle or dynamic, realistic or extravagant, beautiful or arresting lighting effects

Engineered with fresh eyes and a focus on building a versatile, advanced feature set, the RevoPRO™ was designed with the lighting designer in mind.

The RevoPRO™ features

- Dual stepper motors for independent control of speed and direction for each gobo
- Indexing control of BOTH gobos in 8- or 16-bit resolution
- Universal 100-240VAC auto-sensing, auto-switching power supply with standard IEC connector.
- On-board 5-pin DMX input and pass-thru ports
- Flexible programming configurations accommodates simple 2 channel control or advanced moving light console controls
- 99 pre-programmed effects sequences selected using the LED display panel
- Custom programming option to set and store speed and direction without DMX or external controllers
- High temperature silicon belt for smooth, reliable, silent (squeak free) operation;
- Modern stepper motor drives with advanced electronic controls allow the designer to dial speed from 0.5rpm to 24rpm with no risk of stalling;
- Simple, intuitive and user friendly operator modes provide maximum flexibility for programmers of all abilities;
- Threaded gobo collar insures secure fit for any type of gobo – thin metal to thick effects glass.
- Friction Lock™ secure fit mechanism holds the rotator tightly in the iris slot even when the lens barrel is rotated around.

Unleash your imagination and browse through more than 2000 steel and glass gobos at www.rosco.com or design your own pattern, made by Rosco to your precise specifications. The lighting effects you will create with the RevoPRO™ are limitless.

1. THREADED GOBO COLLAR
2. SAFETY CABLE ATTACHMENT
3. FRICTION LOCK
4. LED DISPLAY CONTROLS
5. CONFIGURATION BUTTONS
6. LED DISPLAY DIMMER
7. IEC POWER CONNECTOR (NOT SHOWN)
8. 5-PIN DMX PORTS (NOT SHOWN)

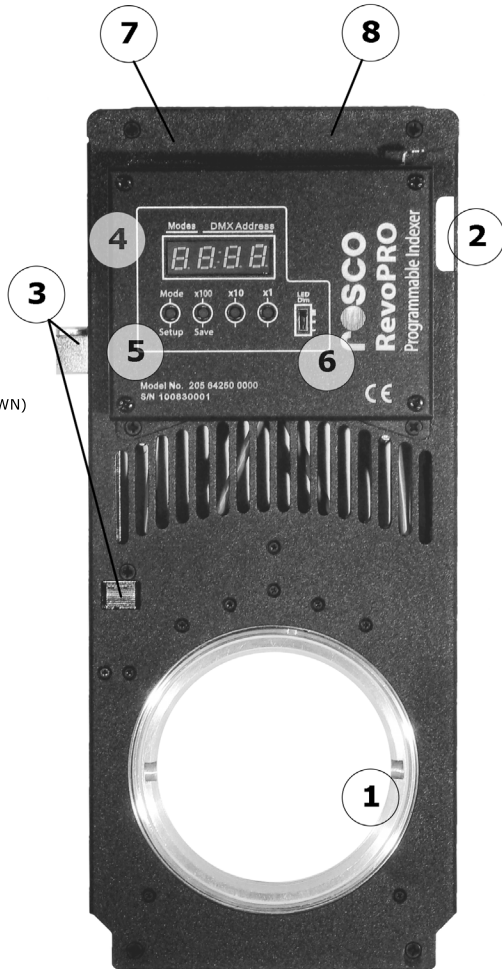

2. WHAT'S IN THE BOX

- RevoPRO™ programmable gobo rotator
- Operator manual
- Quick start card

3. REQUIREMENTS

- 100-240VAC 50/60 hz mains power
- DMX 512 control signal or operate in stand-alone mode
- Modern ellipsoidal spotlight with appropriate sized iris slot including ETC S4, ETC S4 Zoom, Selecon Pacific, Strand SL and Altman Shakespeare, among others.
- B size steel or glass gobos

4. SPECIFYING AND INSTALLING GOBOS

Your Rosco RevoPRO Dual Programmable Rotator will accept standard B-size gobos of virtually any style, whether steel or glass, b/w or color, textured or flat. A B-size gobo has a diameter of 86mm (3.38in) and an image area of 64.5mm (2.54in).

Many modern luminaires have optical systems capable of projecting a larger image area. The RevoPRO™ has an open aperture of 75mm (2.95in) giving you the flexibility to maximize your projection size by using gobos with a larger image area.

RevoPRO™ will accept a wide range of gobo styles from many manufacturers including Stainless Steel gobos, Colorizers™, Image Glass™, Prismatic™, Colorwaves™, Silk Screen Gobos, B/W Glass gobos, 1C Glass Gobos, 2C Glass Gobos, 3C Glass Gobos, Multi-Color Gobos and many others.

Loading Gobos into your RevoPRO™ rotator

RevoPRO™ has two gobo wheels into which you can load gobo effects. While it is most common to load just one gobo into each wheel, you can stack gobos together into the same wheel position providing your stack does not exceed the total maximum thickness of 3.5mm (0.138in).

All Rosco BeltDriveFx rotators utilize an innovative Threaded Collar to securely hold gobos of varying thicknesses. Unlike the spring clips common in similar equipment, the Threaded Collar screws down to positively lock the gobo in place. This prevents the gobo from slipping during rotation and losing index or centering.

To load a gobo into the gobo wheels

1. Place the rotator on a stable flat surface. Unscrew the Threaded Collar from each gobo wheel (counter-clockwise to unscrew, clockwise to tighten).

There are two flat sections on the collar to give your fingers a place to grip. If the collar has been over tightened and is stuck, another small machined spot on the outer ring allows you to gain purchase when spinning the collar opposite to the entire gobo wheel.



2. Once the Threaded Collars are removed, insert a B size gobo so that it lays flat against the gobo wheel.

TIP: When installing a metal gobo, an optional Gobo Spacer Ring (Part no. 205 83007 0000) is available to increase the separation between the gobos to achieve a wider range of focus effects. This spacer can also be useful if two metal gobos with fine thin details are being used. In the event that the heat from the luminaire causes the gobos to warp towards one another, use of the spacer ring will prevent the gobos from getting tangled together.

3. Screw on the Threaded Collar until just in contact with the gobo. Do not over tighten.

The Threaded Collar has Teflon™ threads to ease rotation and avoid binding however there is still a small risk of cross threading. Do not forcibly screw on the Threaded Collar. If you encounter undue resistance, back off and start again. Lay the Threaded Collar flat onto the ring and slowly and evenly rotate until the threads align and engage properly.

TIP: When screwing on the Collar, place one finger from each hand on the machined flats and slowly rotate the collar, keeping even pressure on both fingers. This helps the threads to engage evenly and prevents binding and cross threading. If you are having difficulties getting the thread to “catch,” slowly spin the Collar CCW while continuing to apply gentle even pressure, then reverse back to CW until the threading begins.

4. Repeat this process for both gobo wheels.

NOTE: *When using Apollo gobos*

Apollo Design manufactures a non-standard “B” sized gobo which has an 80mm diameter. Rosco BeltDriveFx rotators can accept these smaller gobos provided you keep a few considerations in mind. The underside of the Threaded Collar which hold gobos in place has been machined with an 80mm recessed lip. To install an Apollo 80mm gobo, you must insure that the gobo sits in the center of the gobo mounting ring as the Threaded Collar slowly tightens down. Slight wiggling of the gobo during this process helps to find the center recessed ridge.

5. INSTALLATION, POWER AND DATA CONNECTIONS

The RevoPRO™ has been engineered to fit into the bodies of most modern ellipsoidal luminaires including ETC Source Four, ETC S4 Zoom, Selecon Pacific, Selecon Pacific Zoom, Altman Shakespeare and Strand SL among others.

1. Insert RevoPRO™ into the iris slot of the luminaire with the motor box facing forward, towards the lens.

Inserting the rotator in the opposite orientation will cause the motor box to interfere with the shutter handles.

It may be necessary to angle the yoke of the luminaire back to allow access into the accessory iris slot.

On certain luminaires, the sliding cover over the iris slot may have to be removed to allow the RevoPRO™ to fit properly.

Note: When installing into a Selecon Pacific luminaire, align the groove in the edge of the RevoPRO™ body with the rear-most tab of the Iris Slot.

2. When seated fully and completely, the gobo wheel should be centered in the lens tube. If necessary, remove the lens tube and visually confirm that the rotator is seated and aligned properly. It is important that the aperture of the gobo rotator be centered in the optical path of the

luminaire in order to project without obstructions to the gobo design.

3. The RevoPRO™ is equipped with a unique safety feature, the Friction Lock. Depress the metal slider located on the left side of the RevoPRO™ to extend a knurled brake cylinder.

This brake presses against the inside wall of the iris slot, securely holding the RevoPRO™ in place.

Note: To install the RevoPRO™ into your luminaire it is necessary that the Friction Lock Slider be in the UP position, with the lock disengaged.



4. Attach a safety cable to the RevoPRO™ and then to the yoke of your luminaire or other secure point.

The D-cut out in the metal housing to the right of the motor box will accept the spring clip of a standard safety cable or the loop end of a small safety cable.

Power and Data

The RevoPRO™ uses an internal, auto-sensing, auto-switching power supply suitable for almost any location.

1. Connect it to any suitable 100-240VAC 50/60hz power source using an ANSI standard IEC cable.
2. If using a DMX controller, connect a 5-pin DMX cable from your lighting desk/console or from the pass-thru of another DMX device into the DMX input port on your PSU.

6. CHOOSING OPERATION MODE AND SETTING DMX ADDRESS

When powered on, the RevoPRO™ will restore to its previous configuration. If this configuration was an indexing mode (3-7) then the unit will go through a

15 second BOOT process first.

Use the LCD display and buttons B1 – B4 to set Mode and DMX Address.

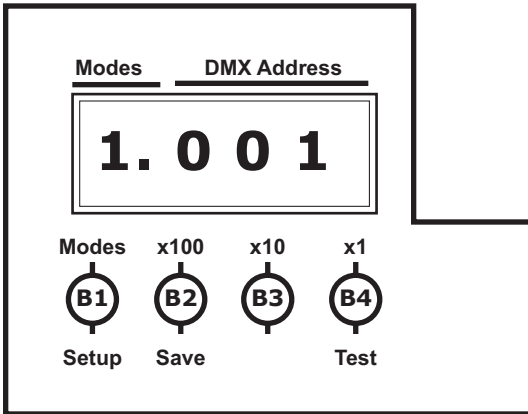

Note: Press = Quick Press ~ 0.25 seconds, Press and Hold = 1 second

To Set Operation Mode

- Press B1 once to enter SETUP . Display will momentarily change to SET- and then return to the previous display, blinking.
- To Change Modes, Press B1 to select the desired mode 1-7 (see below for detailed explanation of the different modes).

For example 2.001 = Mode 2, DMX Address 001.

For Stand Alone Mode or Library Effects, press B1 until E.6XX appears in the display.

- Press and hold B2 to SAVE or continue to set DMX Address.

To Set DMX Address

- If still in SETUP (display blinking) use buttons B2 – B4 to set the three digits of the DMX address desired.
- Press B2 to set 100's place. Keep pressing until desired digit appears.
- Press B3 to set the 10s place.
- Press B4 to set the 1s place.
- For example 3.101 = Mode 3, DMX Address 101.
- Press and hold B2 to SAVE

7. OPERATION MODES

The RevoPRO™ has seven modes of operation to offer the programmer and lighting designer maximum flexibility.

- MODE ONE – 2 Channel - Std Forward Control
- MODE TWO – 2 CH - ML Center Inverse Control
- MODE THREE – 4 CH 8 Bit (Coarse) Indexing – Std Forward Control
- MODE FOUR – 4 CH 8 Bit Indexing ML Center Inverse Control
- MODE FIVE – 6 CH 16 Bit (Fine) Indexing - Std Forward Control
- MODE SIX – 6 CH 16 Bit (Fine) Indexing ML Center Inverse Control
- MODE SEVEN – 4 CH Indexing Shortest Path – 8 bit
- STAND ALONE – No DMX required

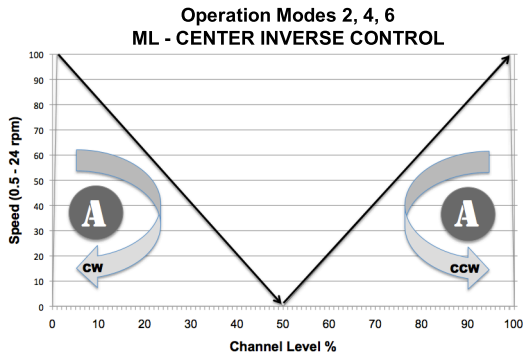
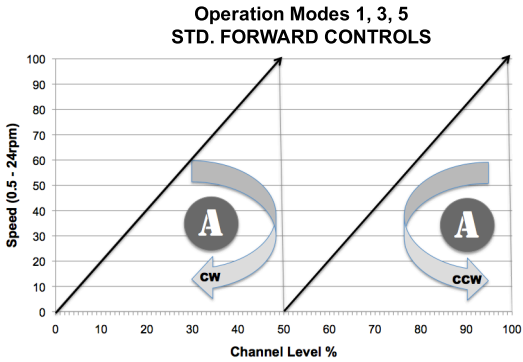

MODE ONE: 2 CH Forward Control

Mode One provides simple control of Gobo A and Gobo B using only two channels of DMX. Channel 1 controls Gobo A, Channel 2 controls Gobo B. Speed and direction of each gobo is adjusted by varying the level of the appropriate channel. Adjust Channel 1 from 0 to 50% (0 – 127 DMX value) to rotate Gobo A clockwise. Adjust Channel 1 from 51 – 99% (128 – 254) to rotate Gobo A Counter-Clockwise. 0% (DMX 0), 50% (DMX 128) and 100% (DMX 255) are full stop.

Adjust Channel 2 to control Gobo B similarly.

Note: Clockwise is determined when looking down the light path from the point of view of the lamp, with the motor box facing away from you.

Mode 1 Channel assignments

CH	Level	DMX	Function / Result
1	0	0	Gobo A - Stop
2	0	0	Gobo B - Stop
1	1-49	1-127	Gobo A - CW (slow to fast)
1	50	128	Gobo A - Stop
1	51-99	129-254	Gobo A - CCW (slow to fast)
1	FL	255	Gobo A - Stop
2	1-49	1-127	Gobo B - CW (slow to fast)
2	50	128	Gobo B - Stop
2	51-99	129-254	Gobo B - CCW (slow to fast)
2	FL	255	Gobo B - Stop

MODE TWO: 2 CH - ML Center Inverse Control

Similar to Mode one, Mode Two provides simple two channel control of the RevoPRO™. For programmers who prefer it, the speed and direction control is more similar to that used by automated lighting programmers. Speed control configuration is “center inverse.” In this mode, slowest speed in both directions is set at the 50% (DMX 128) point on the channel. To increase speed in the clockwise directions, adjust the level down from 50% (DMX 128) to 1% for full speed. 0% is full stop. To increase speed in the Counter Clockwise direction, adjust the level up from 50% to 99%.

Adjust Channel 2 to control Gobo B similarly

Mode 2 Channel assignments

CH	Level	DMX	Function / Result
1	0	0	Gobo A - Stop
2	0	0	Gobo B - Stop
1	1-49	1-127	Gobo A - CW (fast to slow)
1	50	128	Gobo A - Stop
1	51-99	129-254	Gobo A - CCW (slow to fast)
1	FL	255	Gobo A - Stop
2	1-49	1-127	Gobo B - CW (Fast to slow)
2	50	128	Gobo B - Stop
2	51-99	129-254	Gobo B - CCW (slow to fast)
2	FL	255	Gobo B - Stop

MODE THREE: 4 CH Indexing – 8 bit resolution - Forward Control

Indexing is a feature where the designer can specifically stop the rotation at a certain location. This is useful for some effects like Clock or See-Saw movements, but it is also useful with an I-Cue Mirror when you need to keep the orientation of a gobo very specific, as with a logo. Mode Three allows for simple, low resolution indexing using only 2 channels per gobo. As in Mode One, speed and direction for Gobo A is controlled by Channel 1, speed and direction for Gobo B controlled by Channel 2. Channel 3 is used to set the position of between 1-degree and 370-degrees of Gobo A. Channel 4 is used to set the position of Gobo B between 1-degree and 370-degrees. For precise programming, program the index using DMX values, not channel percentages.

Example: To set Gobo A rotating at full speed, set CH1 = 99% and set CH3 = 0. To now stop Gobo A at a precise orientation, set CH 3 = DMX 127 (or any other value > 0). Rotation will continue until the exact orientation is achieved and then stop. To continue rotating, set CH3 = 0.

Mode 3 Channel assignments

CH	Level	DMX	Function / Result
1	0	0	Gobo A - Stop
2	0	0	Gobo B - Stop
1	1-49	1-127	Gobo A - CW (slow to fast)
1	50	128	Gobo A - Stop
1	51-99	129-254	Gobo A - CCW (slow to fast)
1	FL	255	Gobo A - Stop

CH	Level	DMX	Function / Result
3	0	0	Gobo A - Continuous rotation
3	1-100	1-255	Gobo A - Index position 0-370° 1.45° per DMX value
2	1-49	1-127	Gobo B - CW (slow to fast)
2	50	128	Gobo B - Stop
2	51-99	129-254	Gobo B - CCW (slow to fast)
2	FL	255	Gobo B - Stop
4	0	0	Gobo B - Continuous rotation
4	1-100	1-255	Gobo B - Index position 0-370° 1.45° per DMX value

MODE FOUR: 4 CH Indexing – 8 bit resolution - ML Center Inverse

Similar to Mode Two, Mode Four uses the center 50% mark on the channel level to control speed and direction of the gobos. And similar to Mode Three, this configuration allows for low resolution indexing of the gobos using Channels 3 & 4.

Mode 4 Channel assignments

CH	Level	DMX	Function / Result
1	0	0	Gobo A - Stop
2	0	0	Gobo B - Stop
1	1-49	1-127	Gobo A - CW (Fast to slow)
1	50	128	Gobo A - Stop
1	51-99	129-254	Gobo A - CCW (Slow to Fast)
1	FL	255	Gobo A - Stop
3	0	0	Gobo A - Continuous rotation
3	1-100	1-255	Gobo A - Index position 0-370° 1.45° per DMX value
2	1-49	1-127	Gobo B - CW (Fast to slow)
2	50	128	Gobo B - Stop
2	51-99	129-254	Gobo B - CCW (Slow to Fast)
2	FL	255	Gobo B - Stop
4	0	0	Gobo B - Continuous rotation
4	1-100	1-255	Gobo B - Index position 0-370° 1.45° per DMX value

MODE FIVE: 6 CH Indexing – 16 bit resolution - Forward Control

16-Bit or high resolution indexing provides very fine position control over the orientation of the gobo but requires 1 extra control channel per gobo to accomplish this. In 8-bit resolution, each point of DMX value changes the position of the gobo by 1.45-degrees. (370-degrees / 255 values of DMX). When projected over long distances, this 1.45-degree step can make for very coarse gobo position control. In 16-Bit, high resolution, each 1.45-degree step is further divided by 255 points of DMX. With this additional channel of precision, the gobo position can be adjusted within 0.005-degrees!

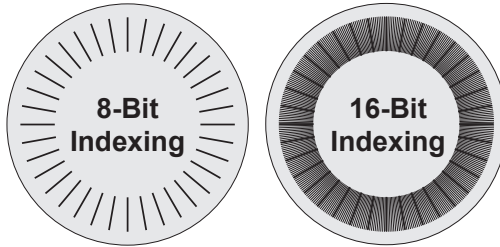

To program in 16-bit resolution, Channels 1 control speed and direction of Gobo A. Channel 3 sets the coarse position of Gobo A. Channel 4 sets the fine position of Gobo A (precisely adjusting the coarse point set by Channel 3).

Channels 2, 5, & 6 similarly control Gobo B.

Mode 5 Channel assignments

CH	Level	DMX	Function / Result
1	0	0	Gobo A - Stop
2	0	0	Gobo B - Stop
1	1-49	1-127	Gobo A - CW (Slow to Fast)
1	50	128	Gobo A - Stop
1	51-99	129-254	Gobo A - CCW (Slow to Fast)
1	FL	255	Gobo A - Stop
3 + 4	0	0	Gobo A - Continuous rotation
3	1-100	1-255	Gobo A - Coarse Index 0-370° 1.45° per DMX value
4	1-100	1-255	Gobo A - Fine Index .005° per DMX value
2	1-49	1-127	Gobo B - CW (Slow to Fast)
2	50	128	Gobo B - Stop
2	51-99	129-254	Gobo B - CCW (Slow to Fast)
2	FL	255	Gobo B - Stop

CH	Level	DMX	Function / Result
5 + 6	0	0	Gobo B - Continuous rotation
5	1-100	1-255	Gobo B - Coarse Index 0-370° 1.45° per DMX value
6	1-100	1-255	Gobo B - Fine Index .005° per DMX value

MODE SIX: 6 CH Indexing – 16 bit resolution - ML Center Inverse

Mode Six is similar to Mode 5 except Speed and Direction controls are configured to Center Inverse like in Modes Two and Four.

Mode 6 Channel assignments

CH	Level	DMX	Function / Result
1	0	0	Gobo A - Stop
2	0	0	Gobo B - Stop
1	1-49	1-127	Gobo A - CW (Fast to Slow)
1	50	128	Gobo A - Stop
1	51-99	129-254	Gobo A - CCW (Slow to Fast)
1	FL	255	Gobo A - Stop
3 + 4	0	0	Gobo A - Continuous rotation
3	1-100	1-255	Gobo A - Coarse Index 0-370° 1.45° per DMX value
4	1-100	1-255	Gobo A - Fine Index .005° per DMX value
2	1-49	1-127	Gobo B - CW (Fast to slow)
2	50	128	Gobo B - Stop
2	51-99	129-254	Gobo B - CCW (Slow to Fast)
2	FL	255	Gobo B - Stop
5 + 6	0	0	Gobo B - Continuous rotation
5	1-100	1-255	Gobo B - Coarse Index 0-370° 1.45° per DMX value
6	1-100	1-255	Gobo B - Fine Index .005° per DMX value

MODE SEVEN: 4 CH Indexing Shortest Path – 8 bit

In Mode Seven, control of speed, direction, and 8-bit index position is separated into 2 channels for each gobo. Channel 1 sets Gobo A to rotating CW,

increasing speed from 0-100% (0-255 DMX). Channel 2 will set Gobo A spinning CCW, speed varying from 0-100% based on level. If BOTH Channel 1 and 2 are at levels other than 0, then Channel 2 sets the 8 bit index position. The gobo will rotate, at the speed set by Channel 1 until it reaches the index point set by Channel 2 and then stop. If either channel is then taken to 0, rotation will resume with speed and direction according to the level set on the active channel.

Control of Gobo B uses Channels 3 & 4 similarly.

Mode 7 Channel assignments

CH	Level	DMX	Function / Result
1 2	0 0	0 0	Gobo A - Stop
1 2	1-100 0	1-255 0	Gobo A - CW (Slow to Fast)
1 2	0 1-100	0 1-255	Gobo A - CCW (Slow to Fast)
1 2	1-100	1-255 1-255	Gobo A - CW speed to index position Gobo A - Index 0-370° (1.45°/DMX)
3 4	0 0	0 0	Gobo B - Stop
3 4	1-100 0	1-255 0	Gobo B - CW (Slow to Fast)
3 4	0 1-100	0 1-255	Gobo B - CCW (Slow to Fast)
3 4	1-100	1-255 1-255	Gobo B - CW speed to index position Gobo B - Index 0-370° (1.45°/DMX)

EFFECTS LIBRARY – NO DMX

The RevoPRO can be configured to operate with no DMX signal present by using the LED Display Panel to recall and apply one of 10 pre programmed effects sequences to either Gobo A or Gobo B. By combining any of these 10 sequences, a total of 100 variations can be achieved. The list of pre-programmed effects is:

- 0 = Continuous rotation
- 1 = Swing 181°
- 2 = Swing 80°
- 3 = Swing 21°
- 4 = Swing 360°

- 5 = Slide 116° with speed (slow to fast)
- 6 = Clock ticking
- 7 = Shaking and rotate
- 8 = Slide 360° with speed (slow to fast)
- 9 = March 5°, 5°, 5°, 5°, stop and continuous

Once applied to a specific gobo wheel, you can further set speed and direction of each of these sequences.

1. Press B1 once to enter SETUP . Display will momentarily change to SET- and then return to the previous display, blinking.
2. Press B1 until E.6XX appears in the display.
Each X corresponds to the effect applied to gobo wheel A and B respectively. For example E.600 indicates that Effect 0 (continuous rotation) has been applied to Gobo A and Gobo B. E.637 indicates that Effect 3 (swing 21°) has been applied to Gobo A and Effect 7 (Shaking and Rotate) has been applied to Gobo B.
3. Press B3 to increment the Effect Number for Gobo A
4. Press B4 to increment the Effect Number for Gobo B
5. Press B2 once. Display will show A._XX for speed and direction of GOBO A
6. Press B4 to increase speed. Positive numbers indicate CW rotation.
7. Press B3 to decrease speed. Negative numbers indicate CCW rotation.
8. Press B2 again to switch to Gobo B. Display will show B._XX
9. Press B4 to increase speed. Positive numbers indicate CW rotation.
10. Press B3 to decrease speed. Negative numbers indicate CCW rotation.
11. Press and hold B2 to SAVE.

Depending on the effects sequence selected, RevoPRO may run through a homing sequence before activating the specified effects. To adjust the speed and direction of this program, repeat steps 1-12 without changing the Effects numbers in steps 1-4. RevoPRO will recall and restore the last programmed effects sequence in the event of a power loss or Operation Mode change.

Note: Some effects sequences (notably, #3, #6, #9) that create quick alternating movements may and which are run at high speeds may cause minor clicking noises due to the fast direction changes. Reduce the speed settings to minimize this.

		GOBO A EFFECT									
		0	1	2	3	4	5	6	7	8	9
GOBO B EFFECT	0	E600	E610	E620	E630	E640	E650	E660	E670	E680	E690
	1	E601	E611	E621	E631	E641	E651	E661	E671	E681	E691
	2	E602	E612	E622	E632	E642	E652	E662	E672	E682	E692
	3	E603	E613	E623	E633	E643	E653	E663	E673	E683	E693
	4	E604	E614	E624	E634	E644	E654	E664	E674	E684	E694
	5	E605	E615	E625	E635	E645	E655	E665	E675	E685	E695
	6	E606	E616	E626	E636	E646	E656	E666	E676	E686	E696
	7	E607	E617	E627	E637	E647	E657	E667	E677	E687	E697
	8	E608	E618	E628	E638	E648	E658	E668	E678	E688	E698
	9	E609	E619	E629	E639	E649	E659	E669	E679	E689	E699

STAND ALONE MODE - USER DEFINED ROTATION

To set and store your own rotation effect, use Effect 0 Continuous Rotation applied to both gobos. This allows you to define the exact speed and direction of each gobo and recall this customized specification without using a DMX console.

1. Press B1 once to enter SETUP . Display will momentarily change to SET- and then return to the previous display, blinking.
2. Press B1 until E.600 appears in the display.
3. Press B2 once. Display will show A._XX for speed and direction of GOBO A
4. Press B4 to increase speed. Positive numbers indicate CW rotation.
5. Press B3 to decrease speed. Negative numbers indicate CCW rotation.
6. Press B2 again to switch to Gobo B. Display will show B._XX
7. Press B4 to increase speed. Positive numbers indicate CW rotation.
8. Press B3 to decrease speed. Negative numbers indicate CCW rotation.

9. Press and hold B2 to SAVE.

8. PRECAUTIONS

- Use only properly rated IEC power cord (18AWG 3C SJT) and connect only to compatible voltage supplies (100-240v 50-60hz)
- Always use a safety cable to insure the RevoPRO™ cannot fall out of the fixture.
- Do not allow power cord to come in contact with the hot body of the luminaire or the rear lamp cap.
- Keep fingers clear of moving parts.
- The metal case of the RevoPRO™ may get very hot after continuous use in a luminaire. Use caution to avoid burns when handling units that have been in running luminaires.

9. TROUBLESHOOTING

1. The RevoPRO™ will not fit into the Iris Slot.
 - a. Make sure the Friction Lock is in the up (disengaged) position and that the lock itself is not extending outside the metal case.
 - b. The iris slot cover of the luminaire may need to be removed to allow complete access to the slot. Fully remove the two screws holding the cover and lift off. Set aside so that the cover can be reinstalled at a later date.
 - c. Installing the RevoPRO™ into the Selecon Pacific Coolight requires that the guide channel in the side cut of the RevoPRO™ align with the rear guide track in the Pacific's iris slot.
 - d. Note: RevoPRO™ is not compatible with Philips/Selecon SPX or Leviton LEO.
2. Threaded Collar will not tighten down on gobo
 - a. Check that Threaded Collar is not cross-threaded. Gently unscrew the Threaded Collar. Reset gobo and re-thread Threaded Collar following the instructions in Section 4, Installing Gobos.
3. The projected gobo appears out of round or cut off.
 - a. The RevoPRO™ is not properly seated in the luminaire. Remove RevoPRO™ unit and reinsert making sure that the unit is seated all the way down in the light.
 - b. Note: The Selecon SPX and Leviton Leo luminaires are not currently compatible with the RevoPRO™ rotator.
4. RevoPRO™ is powered on but no LED lights appear to indicate that

- the unit is receiving power.
- a. Check LED DIM switch is set to the UP position.
 - b. Confirm power to IEC cable.
5. Display is alternating LOST 512-.
- a. RevoPRO™ is not receiving DMX signal. Check connections and console. Troubleshoot to isolate valid DMX.
6. Display is flashing 1.001 or similar sequence of numbers
- a. RevoPRO™ is in Setup mode. Use buttons to assign proper MODE and DMX Address and then Press and Hold button B2 to SAVE assignment.
7. Gobo rotation is erratic and irregular.
- a. Make sure Threaded Collar is tight enough on the gobo to prevent slipping. Do Not Over Tighten.
 - b. If using two steel gobos, check to make sure gobos have not warped towards one another and become entangled. If this has happened, use a Gobo Spacer Ring (205 83007 0000) underneath one or both metal gobos.
8. Channel is at full but gobo is not rotating.
- a. Channel levels 0, 50% and 100% (DMX 0, 128, 255) all represent STOP values for rotation. 1-49 and 51-99 are channel levels that increase or decrease speed.
9. RevoPRO™ is operating but will not respond to DMX.
- a. Check MODE. If Display reads E.6XX, RevoPRO is in Stand Alone mode. Press B1 to enter Setup mode. Use B2 – B4 to assign Mode and DMX Address as intended. Press and hold B2 to Save.
10. RevoPRO™ is behaving oddly and other DMX devices in the same chain are also behaving oddly.
- a. Confirm DMX addressing for all units. Remember that in some modes, RevoPRO™ will use 2, 4, or 6 channels of DMX. Make sure no two device share DMX address assignments.
 - b. Check cable connections for faults.
 - c. Check console. Troubleshoot to validate good DMX signal.
11. Motor is turning, but one or both gobos are not turning.
- a. Check belts. Replace if broken. Reset if out of alignment.
 - b. Check to see if gobos have warped and are entangled. If necessary, use a Gobo Spacer Ring (205 83007 0000) underneath one or both metal gobos.

- c. Check DMX Mode and programming. Channel assignments and motor control operation vary by mode. Confirm correct programming parameters for selected MODE.
12. Gobo rotation appears normal but stops when channel is brought to FULL or 100%.
- a. Check MODE selection. In Mode 2, 4, or 6 this is NORMAL operation. 99% (DMX 254) is FULL speed. 100% (DMX 255) is STOP.

10. Technical Specifications

Dimensions (w x h x d)

4.68in x 10.9in x 0.53/2.5in
119mm x 277mm x 13.4/63.6mm

Weight

31 oz (0.88Kg)

Electrical

Input: 100-240VAC 50/60hz
Max Power Draw: 1A
Connector Type: IEC C13
DMX: 5-pin XLR

Operation

Speed 0.5 - 24 rpm
Operation 2, 4, or 6 channel DMX control
400-degree indexing on both gobos
8-bit or 16 bit resolution
On-board custom programming
99 stand-alone effect sequences

Gobos Type and Sizes

86mm Std B Size (metal or glass)
Apollo B (80mm) metal or glass
86mm OD x 75mmIA x 3.5mm thick
(maximum dimensions)

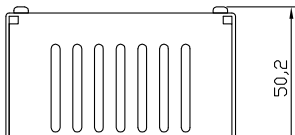
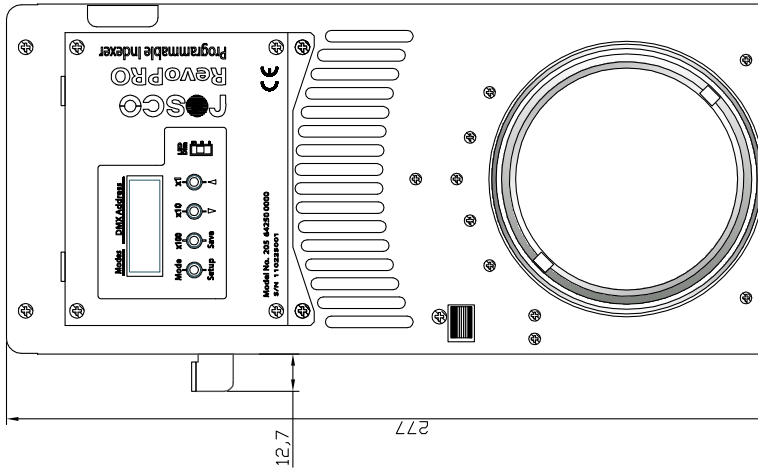

11. ACCESSORIES AND PARTS

Metal and Glass Gobos	www.rosco.com/us/gobos
Gobos Spacer Ring	Part No. 205 83007 0000
Threaded Collar – Gobo mounting wheel	Part No. 205 65002 0001
Silicon Belts – Set of 2 – Simple Spin	Part No. 205 65310 0000
Silicon Belts – Set of 2 – Revo & RevoPRO	Part No. 205 65420 0000
Safety Cable	Part No. 205 65008 0001
Power Cord 16/3 IEC - 6ft (1.8m)	Part No. 226 19903 0119
4-Pin Power / Data Cable – 25 ft	Part No. 205 70002 0025
5-Pin DMX Cable – 25 ft	Part No. 201 50425 0025
PSU 50	Part No. 205 71402 0050
PSU 51 (includes DMX pass-thru)	Part No. 205 71402 0051
PSU 200	Part No. 205 71402 0200

DECLARATION OF CONFORMITY

ROSCO LABORATORIES INC.,
52 Harbor View Ave
Stamford, CT 06902
United States

Hereby declares that the product(s):

Rosco DMX Iris, Rosco Simple Spin, Rosco REVO, Rosco Revopro

Model Number(s)

74500, 63100, 64200, 64250

Conform(s) to the following Product Specifications:

European Council Directive 2004 / 108 / EC

EN 61326-1:2006, EN 61000-3-2:2006, EN 61000-3-3, 1995+A1:2001+A2:2005

European Council Directive 2006 / 95 / EC

EN 61010-1:2001

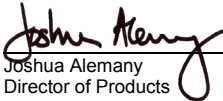

Joshua Alemany
Director of Products

Date: June 11, 2009

13. Warranty

The warranty protection described below covers the following list of Rosco lighting effects equipment (the “Product”): Vortex 360 Gobo Rotator (all styles), DHA Gobo Rotators (all styles), DHA Animation Motor (all styles), Infinity Animation System (all styles), I-Cue Moving Mirror, X24 Effects Projector (all styles), PSU 50, PSU 51, PSU 200, PSU 400, Simple Spin Rotator, REVO Rotator, and RevoPRO Rotator.

1 YEAR LIMITED WARRANTY

Rosco Laboratories warrants to the first retail purchaser that this Product will be free from defects in workmanship and material for a period of twelve (12) months from the date of original purchase. For warranty service you must be able to provide proof of purchase.

Should this Product prove defective during the warranty period, please contact your local Rosco office for return authorization. No warranty service will be performed without Return Authorization. At Rosco’s sole discretion, covered Products will be repaired or replaced with new or refurbished equipment or a model of like kind and quality. Exchanged or replaced parts and Products assume the remaining warranty period of the original Product covered by this limited warranty.

You are responsible for securely packaging the defective Product and returning it to Rosco as per the instructions on the Return Authorization. Within North America, Rosco will ship the repaired or replaced Product to you freight prepaid. Shipments to other locations will be made freight collect.

This warranty is not transferable and does not extend beyond the first retail purchase of the Product. This warranty does not cover damage to the Rosco product caused by parts not manufactured, distributed or certified by Rosco. Rosco is not obligated to provide warranty service should the product fail to be properly maintained or fail to function properly as a result of misuse, abuse, improper installation, neglect, improper shipping, damage caused by disasters such as flood, fire and lightning, improper electrical current or connection or service other than by a Rosco Authorized Servicer. If a claimed defect cannot be identified or reproduced, you will be held responsible for the costs incurred.

Unless otherwise stipulated by state law, all warranties expressed or implied are limited to the twelve (12) month period of this warranty.

THE WARRANTY AND REMEDY PROVIDED ABOVE ARE EXCLUSIVE AND IN LIEU OF ALL OTHER EXPRESS OR IMPLIED WARRANTIES INCLUDING BUT NOT LIMITED TO THE IMPLIED WARRANTIES OF MERCHANTABILITY, NON-INFRINGEMENT OR FITNESS FOR A PARTICULAR PURPOSE. EXCEPT AS PROVIDED IN THIS WRITTEN WARRANTY AND UNLESS EXCLUSIONS ARE SPECIFICALLY FORBIDDEN BY STATE LAW, NEITHER ROSCO NOR ITS AFFILIATES WILL BE LIABLE FOR ANY LOSS, INCONVENIENCE, OR DAMAGE, INCLUDING DIRECT, SPECIAL, INCIDENTAL OR CONSEQUENTIAL DAMAGES, INCLUDING INJURY TO PERSONS OR PROPERTY, RESULTING FROM THE USE OR INABILITY TO USE THE ROSCO PRODUCT, WHETHER RESULTING FROM BREACH OF WARRANTY OR ANY OTHER LEGAL THEORY.

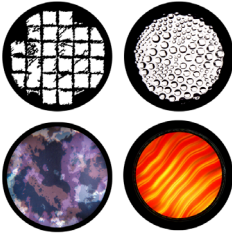

Gobo Library

Rosco's extensive gobo library contains more than 2500 steel and glass designs and contains the inspiration and creative tools to invent almost any lighting effect a designer needs.

www.rosco.com/us/gobos/



Simple Spin™ Dual Gobo Rotator

One of Rosco's BeltDriveFX rotators, the SimpleSpin is a "set and forget" style belt drive gobo rotator. Internal auto-sensing power supply makes for easy installation anywhere in the world.



REVO™ Dual Indexing Rotator

Many of the same features as the RevoPro but powered by an external 24v power supply for convenient installation with common theatrical accessories like color scrollers and I-Cue mirror.



DHA Double Gobo Rotator

Proven reliable for more than 25 years, the Double Gobo Rotator uses a precision engineered gear drive to rotate two gobos independent of one another. Manual and DMX Controllers are available for this 12v device.



Vortex 360 Gobo Rotator

The durability and reliability of a gear drive at a value-engineered price. The Vortex uses an external 12v transformer and is controlled by an on-board speed potentiometer.

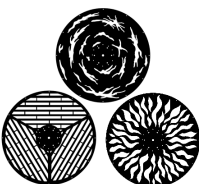

Infinity Animation Effects System

A large rotating disk of your selection animates any gobo with realistic and kinetic movement. Shimmering fire, falling rain, blowing clouds and leaves are among a few of the linear effects created with the Infinity.

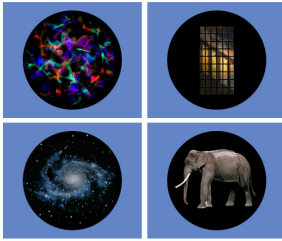

iPro Image Projector

This innovative accessory holds and cools a plastic gobo printed from an ordinary ink jet printer. Project any full color or black and white image you imagine from your Source Four or similar leko within minutes.



I-Cue Moving Mirror

A perfect accessory to expand your light-plot. This silent, accurate motorized mirror attachment turns your simple leko into an infinite number of lighting specials.



X24 Effects Projector

Bright, dynamic, unique rippling light effects. Weighing barely 12 lbs but with a 5000 lumen output, the X24 projector creates dazzling, water and fire effects, aurora borealis, and



Corporate Office

52 Harbor View Ave
Stamford CT 06902

M +1 203 708-8900

F +1 203 708-8919

Toll Free (800) ROSCO NY

info@rosco.com

www.rosco.com

Western US Sales Office

1265 Los Angeles Street
Glendale CA 91204

M +1 818 543-6700

F +1 818 662-9470

Rosco Iberica SA - Spain

C/Oro, 76 Poligono Industrial Sur
28770 Colmenar Viejo, Madrid
Espana

M +34 918 473 900

F +34 918 463 634

info-spain@rosco-iberica.com

Rosco Canada

1241 Denison St #44
Markham, Ontario L3R 4B4

M +1 905 475-1400

F +1 905 475-3351

info@roscocanada.com

Rosco do Brasil

R. Visconde de Itaborai, 141
Tatuape, Sao Paulo - SP
Cep: 03308-050

M +55 2098 2865

F +55 2098 0193

info-brazil@rosco.com

Roscolab Ltd - England

Kangley Bridge Road
Sydenham, London SE26 5AQ
United Kingdom

M +44 20 8659 2300

F +44 20 8659 3153

sales@rosco-europe.com

Rosco Australia PTY Ltd

42 Sawyer Lane, Artarmon
New South Wales 2064

M +(02) 9906 6262

F +(02) 9906 3430

roscoaus@rosco.com.au

www.rosco.com